

Needle Valve

Yoke Series: Large Bore, Reduced Torque
15,000 psi, 43,000 psi, 50,000 psi

15Y, 43Y and 50Y Series



Principle of Operation:

Parker Autoclave Engineers (PAE) Yoke Series valves are extra heavy-duty, plant grade instrument valves for industrial and severe service applications. Designed in accordance with ASME B31.3 Chapter IX standards, yoke valves feature a stainless steel yoke frame that removes the stem threads away from any process leakage past the packing and includes a heavy duty bearing assembly providing low closing torque for ease of operation. Yoke Series valves are designed for use with Parker Autoclave Engineers Medium or High Pressure tubing and fittings.

Medium and High Pressure Yoke Valve Features:

- Temperature Rated -100° to 800°F (-73° to 427°C) with options
- Manufactured as standard with UNS S31600 cold worked 316 stainless steel to PAE proprietary specification
- Metal-to-metal seating achieves bubble-tight shut-off, longer stem/seat life in abrasive flow, greater durability for repeated on/off cycles and excellent corrosion resistance.
- PTFE packing provides below stem threads provide dependable stem and body sealing. Optional packing materials available.
- Stem sleeve and packing gland materials have been selected to achieve extended thread cycle life and reduced handle torque
- Choice of Vee (shutoff) or Flow Regulating stem tips. N-Dura Coating or Stellite® material option for severe service.
- Available in straight or angle body patterns. Replaceable Seat option available.

Traceability is ensured by use of heat and purchase order codes etched on valve body that also includes model number, MAWP rating, and material type references. All valves include connection collar and gland nut unless requested otherwise. Parker Autoclave Engineers' Yoke Style valves are complemented by a complete line of Medium and High Pressure Cone & Thread fittings, tubing, check valves, relief valves, and line filters as required.

Valve Series	Tube Size (inches)	Running Torque inch-lbs. (N.m)	Seating Torque inch-lbs. (N.m)	MAWP psi(bar)
15Y12	3/4" MP	65 (7)	144 (16)	15,000 (1034)
15Y16	1" MP	87 (10)	192 (22)	15,000 (1034)
43Y16	1" HP	300 (34) - 25 ft/lb	540 (61) - 45 ft/lb	43,000 (2965)
50Y9	9/16" HP	85 (10)	180 (20)	50,000 (3450)

All Parker Autoclave Engineers products are designed in accordance with ASME B31.3 Chapter IX High Pressure Piping standards.



ENGINEERING YOUR SUCCESS.

Y Series: Torque Reduction Yoke Valves



Valve Series	Connection Type	Orifice Size Inches (mm)	Rated C_v^*	Pressure Rating psi (bar) @Room Temperature**
15Y12	SF750CX (3/4" MP)	0.438 (11.13)	2.41	15,000 (1034)
15Y16	SF1000CX (1" MP)	0.562 (14.27)	3.15	15,000 (1034)
43Y16	F1000C43 (1" HP)	0.375 (9.53)	2.3	43,000 (2965)
50Y9	F562C (9/16" MP)	0.188 (4.76)	0.66	50,000 (3450)

Notes

* C_v values shown are for 2-way straight valve pattern. For 2-way angle pattern, increase C_v value 50% (Based on water). Formula for converting C_v to volumetric flow can be found in Technical Information section.

** Maximum Allowable Working Pressure decreases as temperatures increase - see pressure/temperature rating guide in Technical Information section.

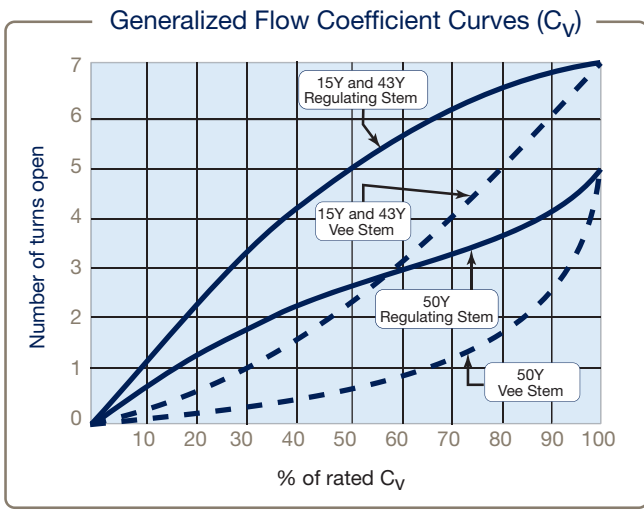

Y Series Flow Curve

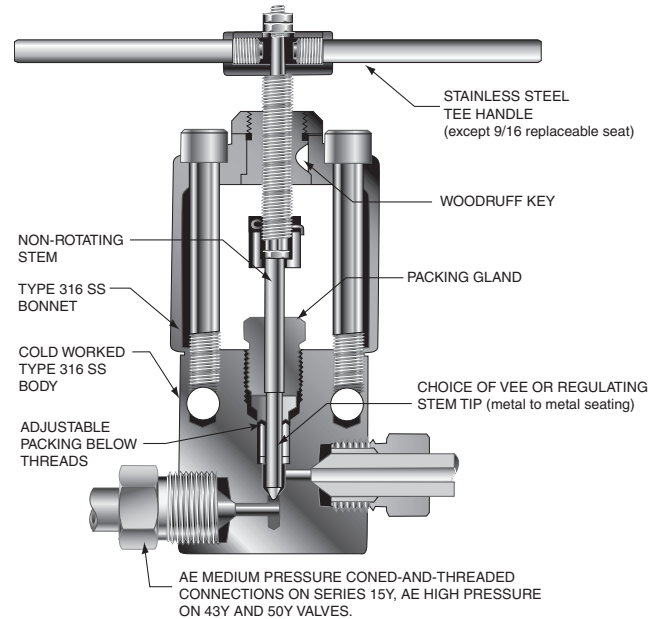

To ensure proper fit use Parker Autoclave tubing

Valve Packing Options:

Standard Parker Autoclave Engineers valves with PTFE packing may be operated from 0°F to 450°F (-18° to 232°C). High and Cryogenic temperature packing and/or extended stuffing box are available for service from -100°F to 600°F (-73° to 315°C) by adding the following suffixes to catalog order number:

- B Standard valve with Cryogenic trim materials and PTFE packing required when below 0° to -100°F (-18° to -73°C)
- TG Standard valve with PTFE-Glass packing -100° to 600°F (-73° to 315°C) See also -B option above when below 0°F (-18°C)
- GY Standard valve with Graphite Yarn packing 32° to 800°F (0° to 427°C)

See "Technical Brochure "for Pressure/Temperature effect on temperatures above ambient.

Ordering Guide:

For complete information on available stem types, optional connections and additional valve options, see Needle Valve Options section or contact your Sales Representative. Y Series valves are furnished complete with connection components, unless otherwise specified.

Building a Part Number: Example: 50Y9071

Example Part Number:	50Y	9	07	1	XX
Ordering Parameters/Options:	Valve Series	Outside Diameter Tube Size	Stem/Seat Type	Body Pattern	Options
Table Reference: (see below)	A	B	C	D	E

A - Valve Series	
15Y	Y Series (Yoke) Needle Valve (3/4" & 1" MP only)
43Y	Y Series (Yoke) Needle Valve (1" HP only)
50Y	Y Series (Yoke) Needle Valve (9/16" HP only)

B - Outside Diameter Tube Size	
9	9/16"
12	3/4"
16	1"

C - Stem/Seal Type	
07	Non-Rotating Vee Stem (on-off service)
08	Non-Rotating Regulating Stem (tapered tip for regulating and shutoff)
87	Vee Stem with Replaceable Seat (angled valve only)
88	Regulating Stem with Replaceable Seat (angled valve only)

D - Body Pattern	
1	2-Way Straight
2	2-Way Angle

E - Options	
For extreme temperatures and other options, see Valve Options.	
TG	PTFE Glass (25%) Packing (-100° to 600°F)
B	Cryogenic (required below 0°F) Trim with and PTFE Packing
GY	High Temperature Graphite Yarn Packing (to 800°F)

See Technical Brochure for Pressure/Temperature effect on temperatures above ambient.

Valve Manuals can be found on our website at www.Autoclave.com, Connection, Running and Seating Torques can be found in the product manual or in our Tools and Installation Catalog Section.

Material of Construction:

Item #	Description	Material
1	Screw, Hex Head	300 Series SS
2	Handle	304 SS
3	Locknut	Plated Steel
4	Bushing	AMPCO 45
5	Upper Stem	316 SS
6	Screw, Socket Head Cap	18-8 SS
7	Stem Retainer	316 SS
8	Split Ring	17-4PH
9	Packing Gland	316 SS
10	Packing Washer	AMPCO 45
11	Packing	PTFE
12	Lower Stem	316 SS
13	Washer	316 SS
14	Hub	316 SS
15	Yoke	316 SS
16	Woodruff Key	Nickel Plated St.
17	Cotter Pin	300 Series SS
18	Thrust Plate	Kennametal K68
19	Grease Fitting	Steel
20	Screw, Round Head	300 Series SS
21	Locking Device	316 SS
22	Spacer	316 SS
23	Bottom Washer	316 SS
24	Body	316 SS
•	Woodruff Key (Handle Hub)	Nickel Plated St.
•	Seat Retainer	316 SS
•	Replaceable Seat	A-286

•	Typical spare parts found in Repair Kits
•	Not shown

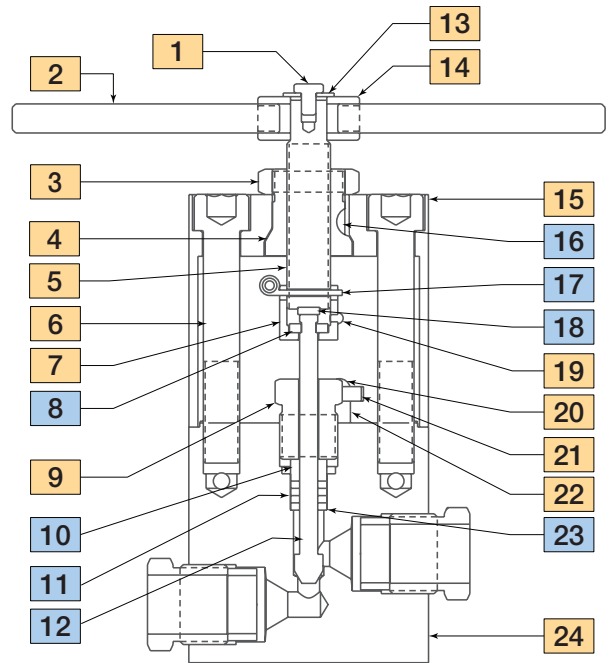

Basic Repair Kits for 316 SS Material:

Basic Repair Kit for 316 SS Material

Stem Type		Outside Diameter Tube:			
		3/4" (15,000 psi)	1" (15,000 psi)	1" (43,000 psi)	9/16" (50,000 psi)
2 Way Straight, 2 Way Angle	VEE	R15Y1207	R15Y1607	R43Y1607	R50Y907
	REG	R15Y1208	R15Y1608	R43Y1608	R50Y908
2 Way Angle Replaceable Seat	VEE	R15Y12872	R15Y16872	R43Y16872	R50Y9872
	REG	R15Y12882	R15Y16882	R43Y16882	R50Y9882

Consult your Parker Autoclave Engineers representative for other kit numbers, body part numbers, and pricing.

Valve Manuals can be found on our website at www.Autoclave.com, Connection, Running and Seating Torques can be found in the product manual or in our Tools and Installation Catalog Section.

Y Series Dimensions:

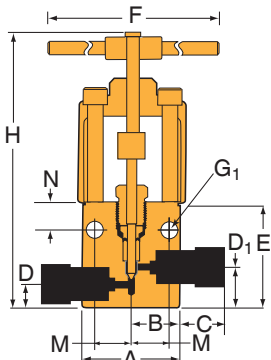
2 Way Straight					
		Catalog Number			
Stem Type	VEE REG	15Y12071 15Y12081	15Y16071 15Y16081	43Y16071 43Y16081	50Y9071 50Y9081
Outside Diameter Tube		3/4" MP (19.05)	1" MP (25.40)	1" HP (25.40)	9/16" HP (14.29)
Orifice Diameter		0.438 (11.13)	0.562 (14.27)	0.375 (9.53)	0.188 (4.78)
Dimensions: inches (mm)					
	A	3.00 (76.20)	4.13 (104.78)	4.13 (104.90)	3.00 (76.20)
	B	1.50 (38.10)	2.06 (52.39)	2.07 (52.45)	1.50 (38.10)
	C	0.63 (15.88)	0.63 (15.88)	0.72 (18.29)	0.56 (14.27)
	D	0.75 (19.05)	0.88 (22.35)	1.00 (25.40)	0.68 (17.48)
	D1	1.50 (38.10)	1.88 (47.75)	1.88 (47.75)	1.25 (31.75)
	E	3.50 (88.90)	4.13 (104.78)	4.13 (104.78)	3.25 (82.55)
	F	8.00 (203.20)	10.25 (260.35)	10.25 (260.35)	13.00 (330.20)
	G	-	-	-	-
	G1	0.28 (7.11)	0.28 (7.11)	0.28 (7.11)	0.50 (12.70)
	H*	9.38 (238.25)	10.00 (254.00)	9.56 (242.82)	8.69 (220.73)
	M	1.13 (28.58)	1.50 (38.10)	1.50 (38.10)	1.13 (28.58)
N	0.88 (22.23)	1.13 (28.58)	1.00 (25.40)	0.88 (22.23)	
Block Thickness		1.38 (34.93)	1.75 (44.45)	1.75 (44.45)	1.38 (34.93)

G - Packing Gland mounting hole drill size • G1 - Bracket mounting hole size • H* - Dimension is with stem in closed position • All dimensions for reference only and subject to change
For prompt service, Parker Autoclave stocks select products. Consult factory.

Y Series Dimensions:

2 Way Angle						
		Catalog Number				
Stem Type	VEE REG	15Y12872 15Y12882	15Y16872 15Y16882	43Y16872 43Y16882	50Y9872 50Y9882	
Outside Diameter Tube		3/4" MP (19.05)	1" MP (25.40)	1" HP (25.40)	9/16" HP (14.29)	
Orifice Diameter		0.438 (11.13)	0.562 (14.27)	0.375 (9.53)	0.188 (4.78)	
Dimensions: inches (mm)		A	B	C	D	
		3.00 (76.20)	4.13 (104.78)	4.13 (104.90)	3.00 (76.20)	
		1.50 (38.10)	2.06 (52.39)	2.07 (52.45)	1.50 (38.10)	
		0.63 (15.88)	0.63 (15.88)	0.72 (18.29)	0.56 (14.27)	
		1.75 (44.45)	2.25 (57.15)	2.31 (58.67)	1.50 (38.10)	
		D1	-	-	-	-
		E	3.75 (95.25)	4.50 (114.30)	4.56 (115.82)	3.50 (88.90)
		F	8.00 (203.20)	10.25 (260.35)	10.25 (260.35)	13.00 (330.20)
		G	-	-	-	-
		G1	0.28 (7.11)	0.28 (7.11)	0.28 (7.11)	0.50 (12.70)
		H*	9.63 (244.48)	10.38 (263.53)	10.80 (274.32)	8.81 (223.82)
		M	1.13 (28.58)	1.50 (38.10)	1.50 (38.10)	1.13 (28.58)
		N	0.88 (22.23)	1.13 (28.58)	1.00 (25.40)	0.88 (22.23)
	Block Thickness		1.38 (34.93)	1.75 (44.45)	1.75 (44.45)	1.38 (34.93)

2 Way Angle, Replaceable Seat						
		Catalog Number				
Stem Type	VEE REG	15Y12872 15Y12882	15Y16872 15Y16882	43Y16872 43Y16882	50Y9872 50Y9882	
Outside Diameter Tube		3/4" MP (19.05)	1" MP (25.40)	1" HP (25.40)	9/16" HP (14.29)	
Orifice Diameter		0.438 (11.13)	0.562 (14.27)	0.375 (9.53)	0.188 (4.78)	
Dimensions: inches (mm)		A	B	C	D	
		3.00 (76.20)	4.13 (104.78)	4.13 (104.90)	3.00 (76.20)	
		1.50 (38.10)	2.06 (52.39)	2.07 (52.45)	1.50 (38.10)	
		0.63 (15.88)	0.63 (15.88)	0.72 (18.29)	0.56 (14.27)	
		2.06 (52.32)	2.06 (52.32)	2.13 (54.10)	1.38 (35.05)	
		D1	-	-	-	-
		E	4.00 (101.60)	4.13 (104.78)	4.38 (111.25)	3.38 (85.75)
		F	8.00 (203.20)	10.25 (260.35)	10.25 (260.35)	4.00 (101.60)
		G	-	-	-	-
		G1	0.28 (7.11)	0.28 (7.11)	0.28 (7.11)	0.28 (7.11)
		H*	11.31 (287.27)	11.75 (298.45)	11.95 (303.53)	12.12 (307.85)
		M	1.13 (28.58)	1.50 (38.10)	1.50 (38.10)	1.13 (28.58)
		N	0.88 (22.23)	1.03 (26.16)	1.00 (25.40)	1.06 (26.97)
	Block Thickness		1.38 (34.93)	1.75 (44.45)	1.75 (44.45)	1.38 (34.93)

G - Packing Gland mounting hole drill size • G1 - Bracket mounting hole size • H* - Dimension is with stem in closed position • All dimensions for reference only and subject to change
For prompt service, Parker Autoclave stocks select products. Consult factory.

Valve Options:

Stem Options:

Most Parker Autoclave Engineers' valves are available with either Vee (on-off) or Regulating (Flow Control) Stems in our standard valve body seat or with our optional replaceable seat as shown below:

VEE Stem

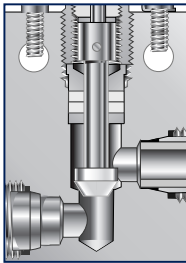

The Vee stem is used for direct on-off, metal-to-metal shut-off with quick-opening flow characteristics.

Regulating Stem

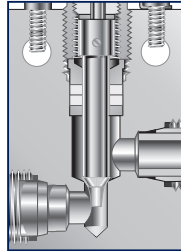

In some applications, more precise flow control is required than is possible with a Vee stem. For these cases, Autoclave offers a non-rotating, two-piece regulating stem which can be used for both control and shut-off. While it is not as precise as the control associated with the MicroMetering stem, especially with smaller flows, it does offer substantially better control than the Vee stem.

Replaceable Seat
(with Vee Stem)

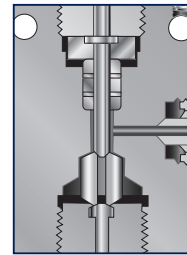

Replaceable seat option is only available with Right-Angle Style body. Replaceable seat is supplied as standard with an additional seat - rotate to use second side. Can be used with either stem type. Options include Stellite material or N-Dura coating to increase service life.

Valve Options:

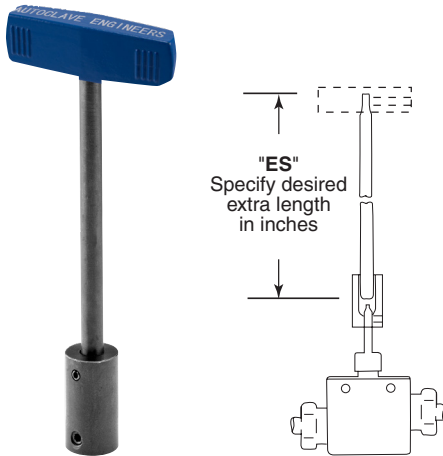

ES Stem Extender:

Stem extenders are offered for High and Low temperature operation or to extend through panel or barricade.

To order valve with Stem Extender, add “**ES-**” and length (6”, 12”, 18”, 24”) to beginning of valve part number e.g. ES12-50Y9071. Other lengths to special order.

To order Stem Extender only, provide valve model prefix e.g. ES12-50Y9. Handle not included – use same provided with original valve.



Needle Valve Clam Shell Handle Lockout:

(order separately using part numbers shown below, padlock not included)

Clam Shell Handle locks are provided to lockout valves in open or closed position preventing unauthorized personnel from actuating valve during shutdown or emergency situations. This clamshell design is available in four (4) sizes dependent on handle length:

P/N 90088 – 2.5" to 5.0" handle length

P/N 90194 – 6.5" to 10" handle length

Parker Worldwide

North America

USA – Corporate, Cleveland, OH
Tel: +1 256 896 3000

USA – IPD, Huntsville, AL
Tel: +1 256 881 2040
ipdcct@parker.com

USA – IPD, (Autoclave), Erie, PA
Tel: +1 814 860 5700
ipdaect@parker.com

CA – Canada, Grimsby, Ontario
Tel: +1 905-945-2274
ipd_canada@parker.com

South America

AR – Argentina, Buenos Aires
Tel: +54 3327 44 4129
falecom@parker.com

BR – Brazil, Diadema, SP
Tel: +55 11 4360 6700
falecom@parker.com

CL – Chile, Santiago
Tel: +56 (0) 2 2303 9640
falecom@parker.com

MX – Mexico, Toluca
Tel: +52 722 275 4200
contacto@parker.com

Asia Pacific

AU – Australia, Dandenong
Tel: +61 (0)2 9842 5150
customer.service.au@parker.com

CN – China, Shanghai
Tel: +86 21 2899 5000
INGtechnical.china@parker.com

HK – Hong Kong
Tel: +852 2428 8008

IN – India, Mumbai
Tel: +91 22 6513 7081-85

ID – Indonesia, Tangerang
Tel: +62 2977 7900
parker.id@parker.com

JP – Japan, Tokyo
Tel: +(81) 3 6365 4020
infophj@parker.com

KR – South Korea, Seoul
Tel: +82 2 559 0400
parkerkr@parker.com

MY – Malaysia, Selangor
Tel: +603 784 90 800
parkermy@parker.com

SG – Singapore,
Tel: +65 6887 6300
parkerkg@parker.com

TH – Thailand, Bangkok
Tel: +66 2 186 7000
phthailand@parker.com

TW – Taiwan, Taipei
Tel: +886 2 2298 8987
enquiry.taiwan@parker.com

VN – Vietnam, Hochi Minh City
Tel: +848 382 508 56
parker_viet@parker.com

Europe, Middle East, Africa

AE – UAE, Dubai
Tel: +971 4 812 7100
parker.me@parker.com

AT – Austria, Wiener Neustadt
Tel: +43 (0)2622 23501-0
parker.austria@parker.com

AT – Eastern Europe, Wiener Neustadt
Tel: +43 (0)2622 23501 900
parker.easteurope@parker.com

AZ – Azerbaijan, Baku
Tel: +994 50 2233 458
parker.azerbaijan@parker.com

BE/LU – Belgium, Nivelles
Tel: +32 (0)67 280 900
parker.belgium@parker.com

BG – Bulgaria, Sofia
Tel: +359 2 980 1344
parker.bulgaria@parker.com

BY – Belarus, Minsk
Tel: +48 (0)22 573 24 00
parker.belarus@parker.com

CH – Switzerland, Etoy
Tel: +41 (0) 21 821 87 00
parker.switzerland@parker.com

CZ – Czech Republic, Klecany
Tel: +420 284 083 111
parker.czechrepublic@parker.com

DE – Germany, Kaarst
Tel: +49 (0)2131 4016 0
parker.germany@parker.com

DK – Denmark, Ballerup
Tel: +45 43 56 04 00
parker.denmark@parker.com

ES – Spain, Madrid
Tel: +34 902 33 00 01
parker.spain@parker.com

FI – Finland, Vantaa
Tel: +358 (0)20 753 2500
parker.finland@parker.com

FR – France, Contamine s/Arve
Tel: +33 (0)4 50 25 80 25
parker.france@parker.com

GR – Greece, Athens
Tel: +30 210 933 6450
parker.greece@parker.com

HU – Hungary, Budapest
Tel: +36 223 885 470
parker.hungary@parker.com

IE – Ireland, Dublin
Tel: +353 (0)1 466 6370
parker.ireland@parker.com

IT – Italy, Corsico (MI)
Tel: +39 02 45 19 21
parker.italy@parker.com

KZ – Kazakhstan, Almaty
Tel: +7 7273 561 000
parker.easteurope@parker.com

NL – The Netherlands, Oldenzaal
Tel: +31 (0)541 585 000
parker.nl@parker.com

NO – Norway, Stavanger
Tel: +47 66 75 34 00
parker.norway@parker.com

PL – Poland, Warsaw
Tel: +48 (0)22 573 24 00
parker.poland@parker.com

PT – Portugal, Leca da Palmeira
Tel: +351 22 999 7360
parker.portugal@parker.com

RO – Romania, Bucharest
Tel: +40 21 252 1382
parker.romania@parker.com

RU – Russia, Moscow
Tel: +7 495 645-2156
parker.russia@parker.com

SE – Sweden, Spånga
Tel: +46 (0)8 59 79 50 00
parker.sweden@parker.com

SK – Slovakia, Banská Bystrica
Tel: +421 484 162 252
parker.slovakia@parker.com

SL – Slovenia, Novo Mesto
Tel: +386 7 337 6650
parker.slovenia@parker.com

TR – Turkey, Istanbul
Tel: +90 216 4997081
parker.turkey@parker.com

UA – Ukraine, Kiev
Tel: +48 (0)22 573 24 00
parker.ukraine@parker.com

UK – United Kingdom, Warwick
Tel: +44 (0)1926 317 878
parker.uk@parker.com

ZA – South Africa, Kempton Park
Tel: +27 (0)11 961 0700
parker.southafrica@parker.com

! CAUTION !

Do not mix or interchange component parts or tubing with those of other manufacturers. Doing so is unsafe and will void warranty.

Parker Autoclave Engineers Valves, Fittings, and Tools are not designed to interface with common commercial instrument tubing and are designed to only connect with tubing manufactured to Parker Autoclave Engineers AES specifications. Failure to do so is unsafe and will void warranty.

WARNING

FAILURE, IMPROPER SELECTION OR IMPROPER USE OF THE PRODUCTS AND/OR SYSTEMS DESCRIBED HEREIN OR RELATED ITEMS CAN CAUSE DEATH, PERSONAL INJURY AND PROPERTY DAMAGE.

This document and other information from Parker Hannifin Corporation, its subsidiaries and authorized distributors provide product and/or system options for further investigation by users having technical expertise. It is important that you analyze all aspects of your application and review the information concerning the product or system in the current product catalog. Due to the variety of operating conditions and applications for these products or systems, the user, through its own analysis and testing, is solely responsible for making the final selection of the products and systems and assuring that all performance, safety and warning requirements of the application are met. The products described herein, including without limitation, product features, specifications, designs, availability and pricing, are subject to change by Parker Hannifin Corporation and its subsidiaries at any time without notice.

Offer of Sale

The items described in this document are available for sale by Parker Hannifin Corporation, its subsidiaries or its authorized distributors. Any sale contract entered by Parker will be governed by the provisions stated in Parker's standard terms and conditions of sale (copy available upon request).



Instrumentation Products Division
Autoclave Engineers Operation
8325 Hessinger Drive
Erie, PA 16509-4679
Tel: 814 860 5700
Fax: 814 860 5811
www.autoclave.com
www.parker.com/ipd

Instrumentation Products Division
Autoclave Engineers Operation,
Houston
15340 Vantage Parkway, East
Houston, TX 77032
Tel: 281 987 3828
Fax: 281 987 2318

Parker Hannifin Manufacturing Ltd.
Instrumentation Products Division,
Europe
Riverside Road
Pottington Business Park
Barnstaple, UK, EX31 1NP, UK
Tel: 44 1271 313131
Fax: 44 1271 373636